

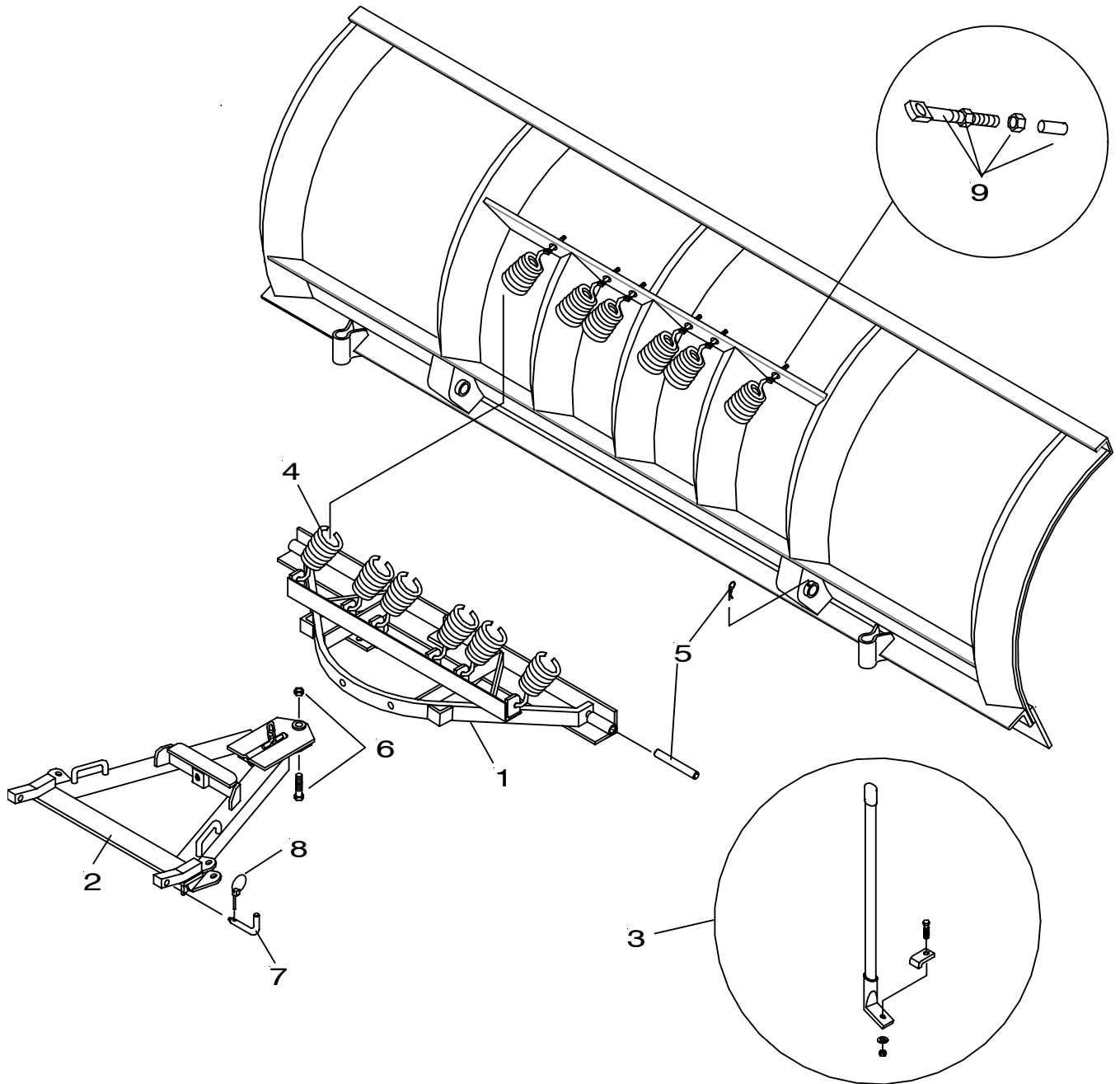

## Parts & Installation Instructions 16489 S.A.F. Carton



### Parts List

Item	Part No.	Qty.	Description
	16489	1	<b>Sector &amp; A-Frame Carton</b>
1	12793	1	• Sector
2	13606	1	• A-Frame 15" x 31" x 23-1/2"
3	09916	1	• Marker Kit
4	07017	6	• Trip Spring
	08556	1	• <b>Hardware Bag</b>
5	09119	2	•• Pivot Pin w/ Fittg. & Hair Pin
6	09125	1	•• King Bolt w/ Locknut
7	10958	2	•• Hinge Pin
8	22083	2	•• Lynch Pin
9	09124	6	•• Eye Bolt w/ Locknut & Cap